

# PACKAGING TOOLKIT

This week we are celebrating Victory in Europe Day with a series of different activities all ending with a wonderful tea party on Friday. Throughout the week we will be providing facts about WW2 and VE Day Celebrations.

## WHAT YOU WILL NEED:



Printer



Scissors



Paper



Glue



Colour Pencils

## MAKE YOUR OWN :



British Tea Party



## HOW TO MAKE:

You can choose whether you want to colour in your own design or use the one that has already been coloured-in by our graphic designer!

### Design 1 & 2:

1. Once you have folded all the flaps, make sure to glue the glue flap on the back of the front panel.
2. Tuck in the side flaps and it will look like a matchbox.

### Design 3:

1. Once you have folded all the flaps, put the two panels with the tea cups back-to-back.
2. Very carefully bend the two side flaps over the the cup tab, one-by-one.

### Design 4:

1. Cut out the carton and fold along all of the crease lines.
2. Place glue on the glue flap and stick to other side panel.
3. Tuck in the bottom and top flaps.

Enjoy your Tea Party.

Share on social media  
using #alexirkidsathome

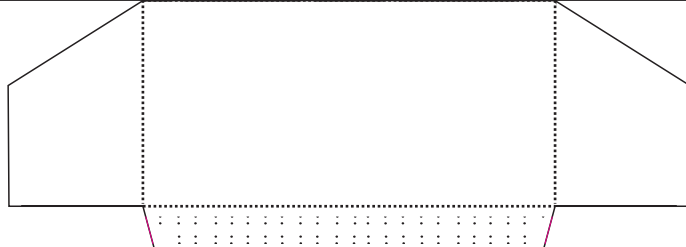
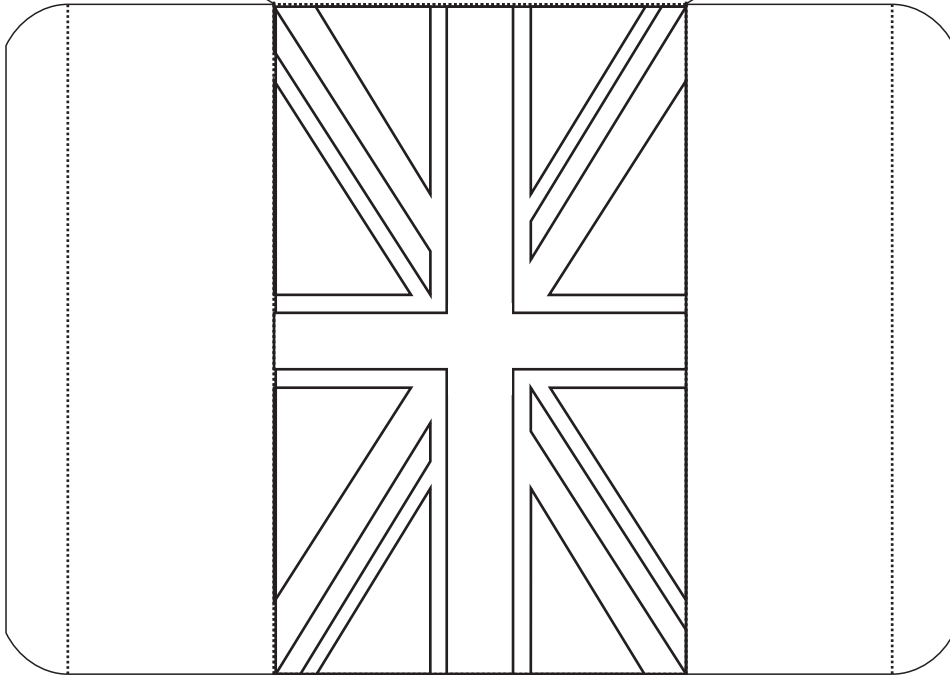
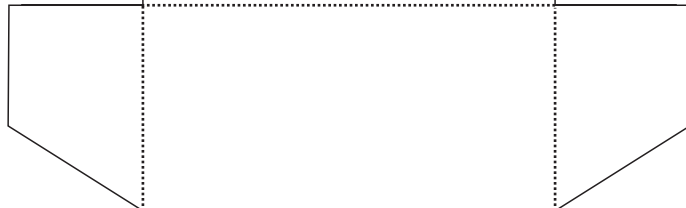
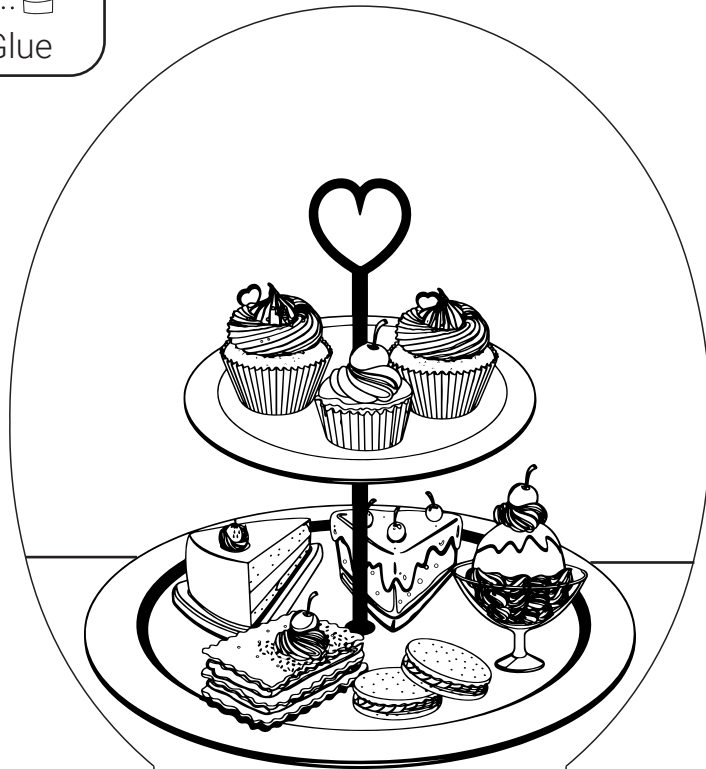
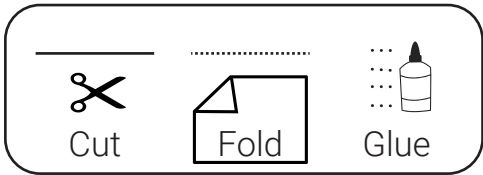

Cut      Fold      Glue

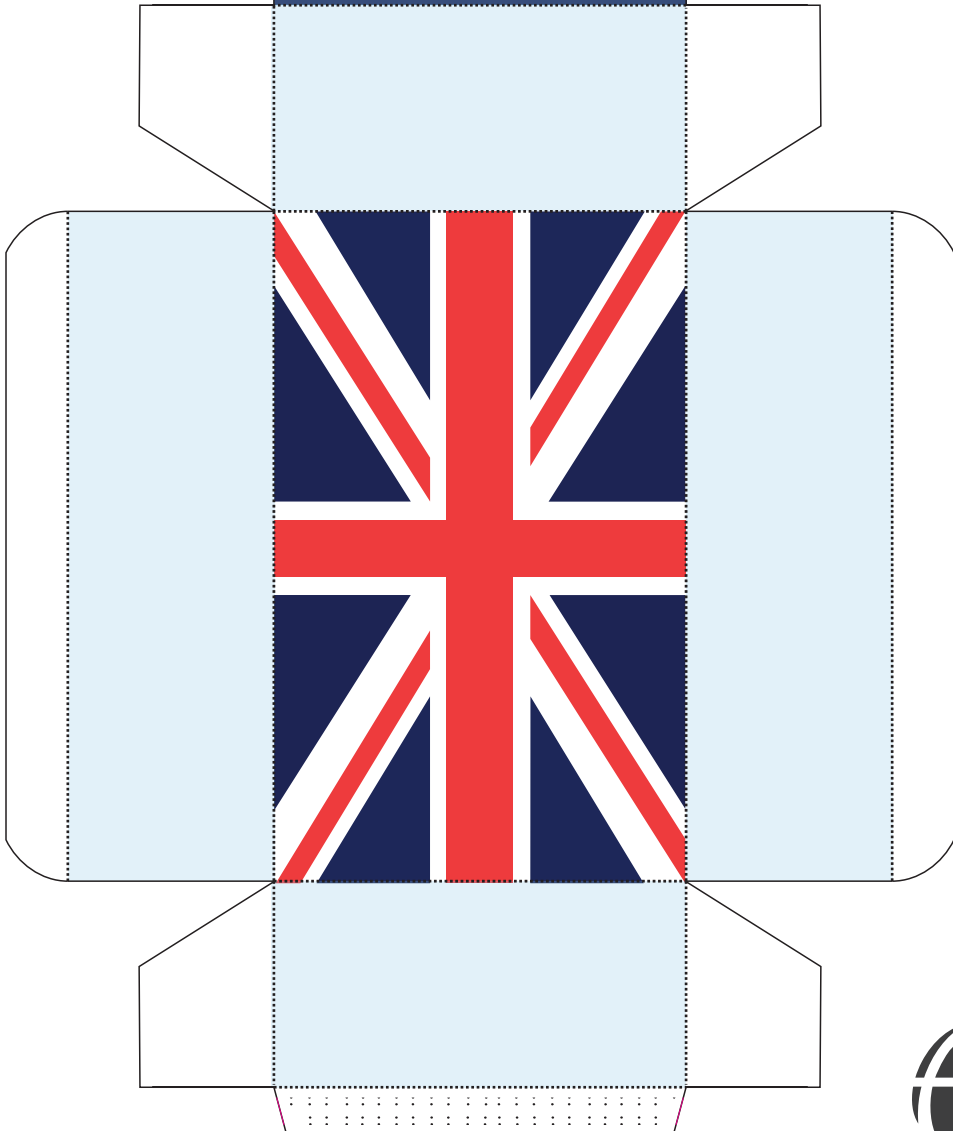

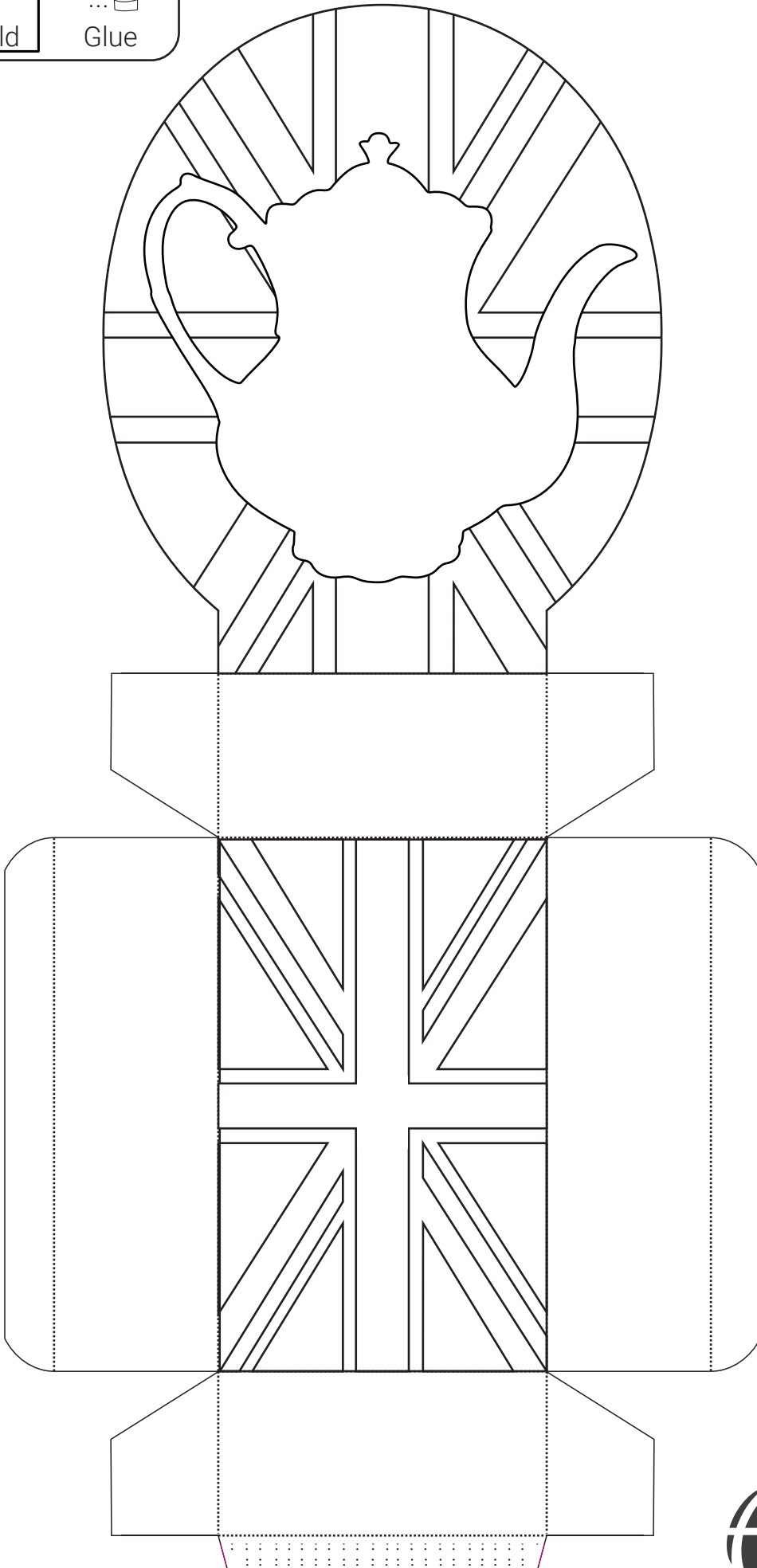
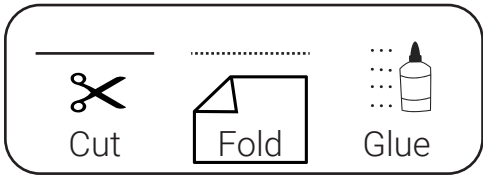

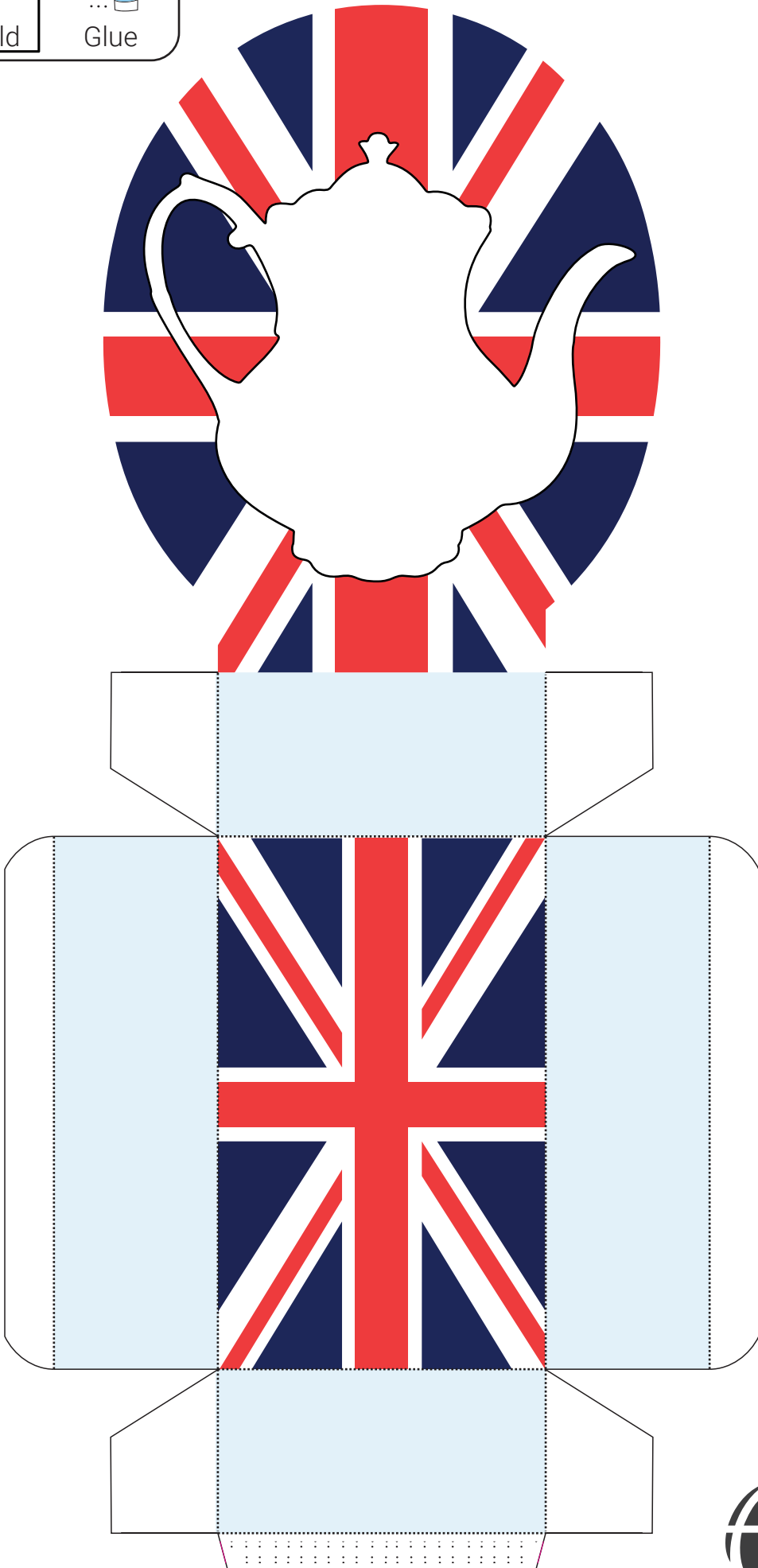
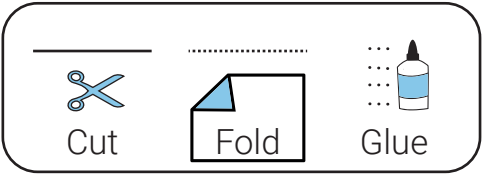

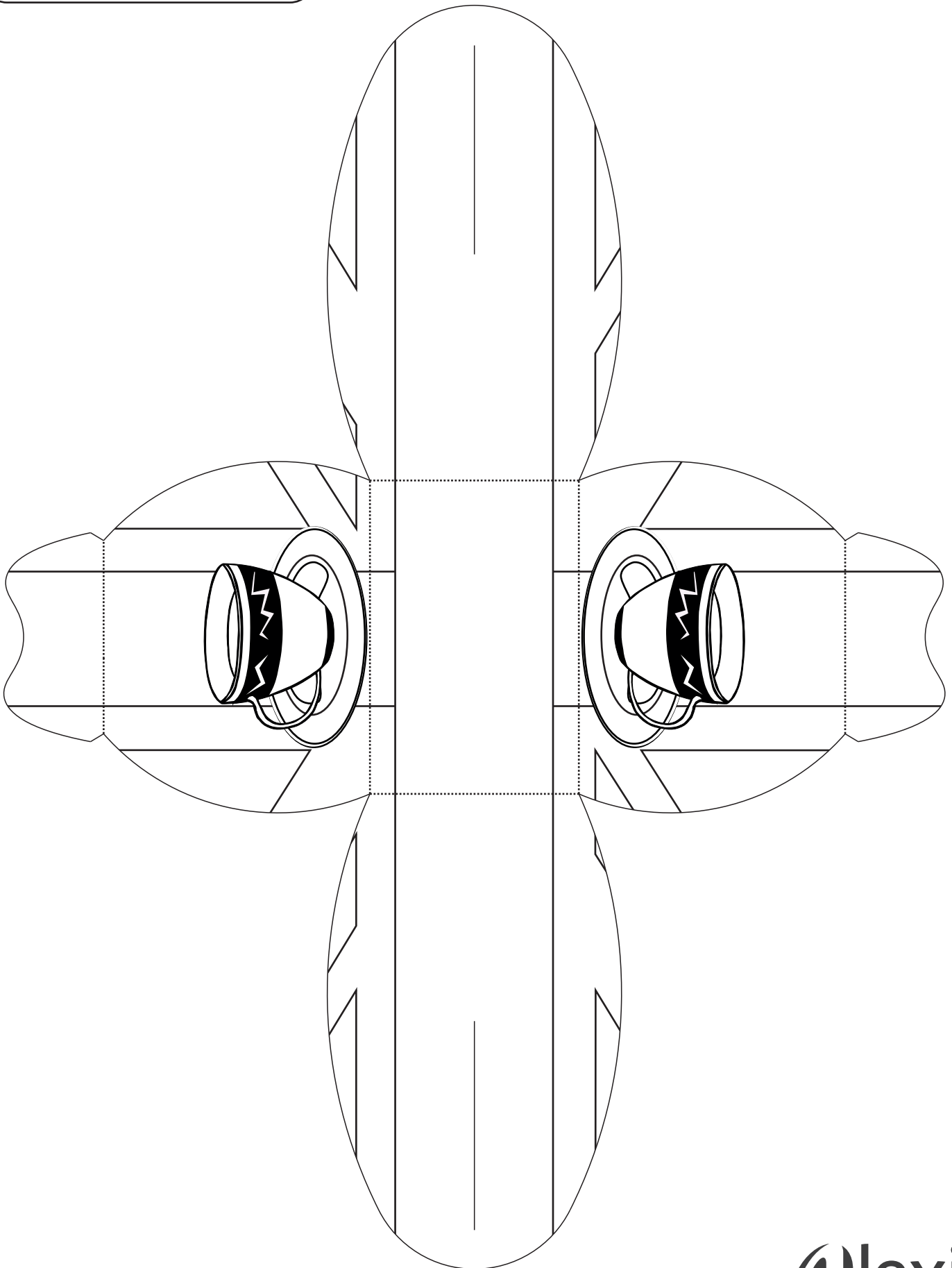
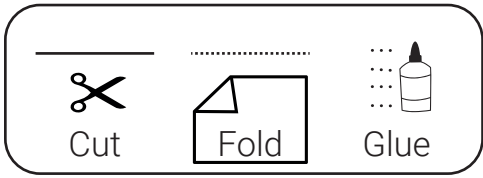

Cut      Fold      Glue

